

- Cor-A-Vented Ridge Flashing
- Box End Panel
- #10-13x1" PHW (5 per panel)
- Cor-A-Vent JM600
- Air Dam
- #10-12x1-1/2" GB Jetmet Head SHC WS(12" o.c.)
- D.B. Tape Sealant
- Jet Metals Approved Tube Sealant
- Z-Closure Flashing
- D.B. Tape Sealant
- JM2500 Panel

note:  
Net Free Area = 20 sq in/ft

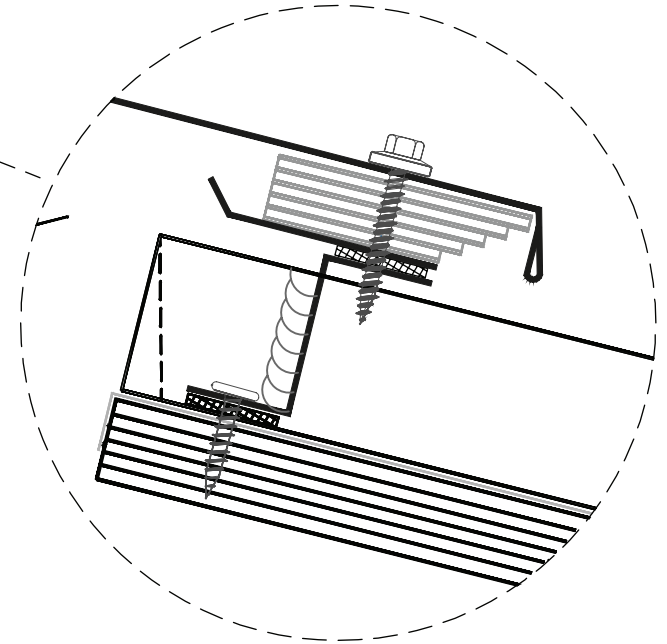

Zoomed in View

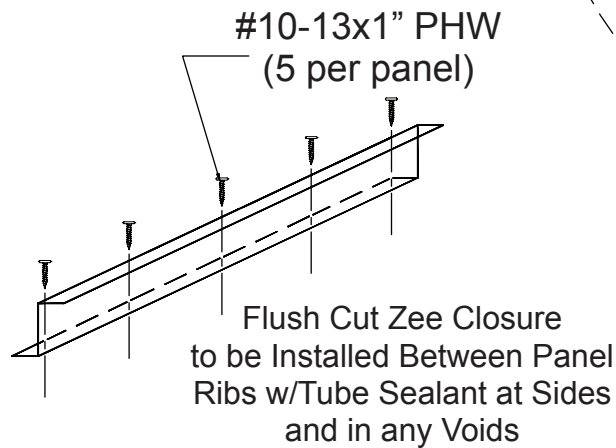

#10-13x1" PHW  
(5 per panel)

Flush Cut Zee Closure  
to be Installed Between Panel  
Ribs w/Tube Sealant at Sides  
and in any Voids

Plywood Substrate

**JET METALS, LLC.**

DRAWING NAME:

**JM2500 COR-A-VENTED RIDGE/HIP**

REV: 0	DRAWING NUMBER:	<b>A</b>	SHEET: 1 of 1
DATE: 06/01/2015	DRAWN BY: Off Balance Digital Art	PAINT:	