

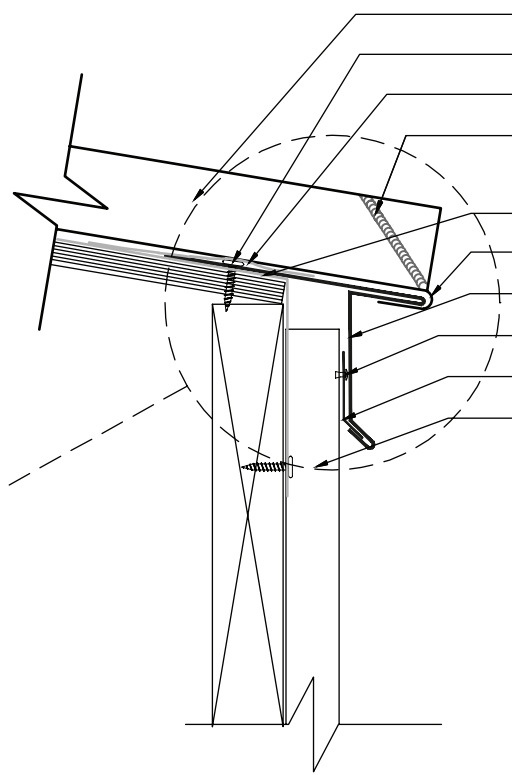

Zoomed in View

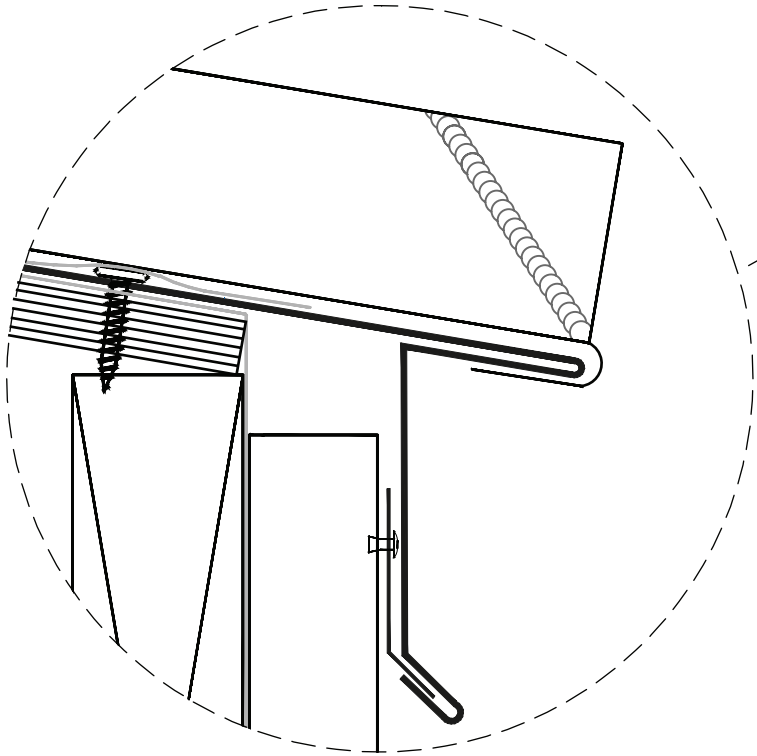

- JM1000 Panel
- #10-13x1" PHW (12" o.c.)
- Jetshield Underlayment
- Jet Metals Approved Tube Sealant
(Field Applied between Panel Ribs)
- Jetshield Underlayment
- Field Cut & Hem Panel 180°
- Drip Edge Flashing
- 1/8"-#43 Pop Rivet (6" o.c.)
- Cleat Flashing
- Wall Panel

Plywood Substrate

JET METALS, LLC.

DRAWING NAME:
**JM1000 Drip Edge
w/Flush Panel**

REV: 0	DRAWING NUMBER:	A	SHEET: 1 of 1
DATE: 06/01/2015	DRAWN BY: Off Balance Digital Art	PAINT:	