

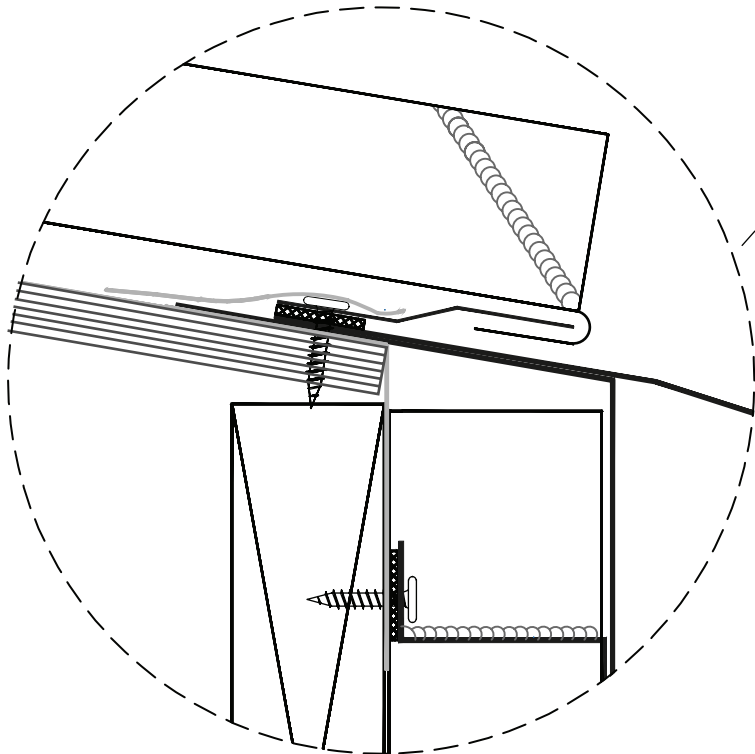

Zoomed in View

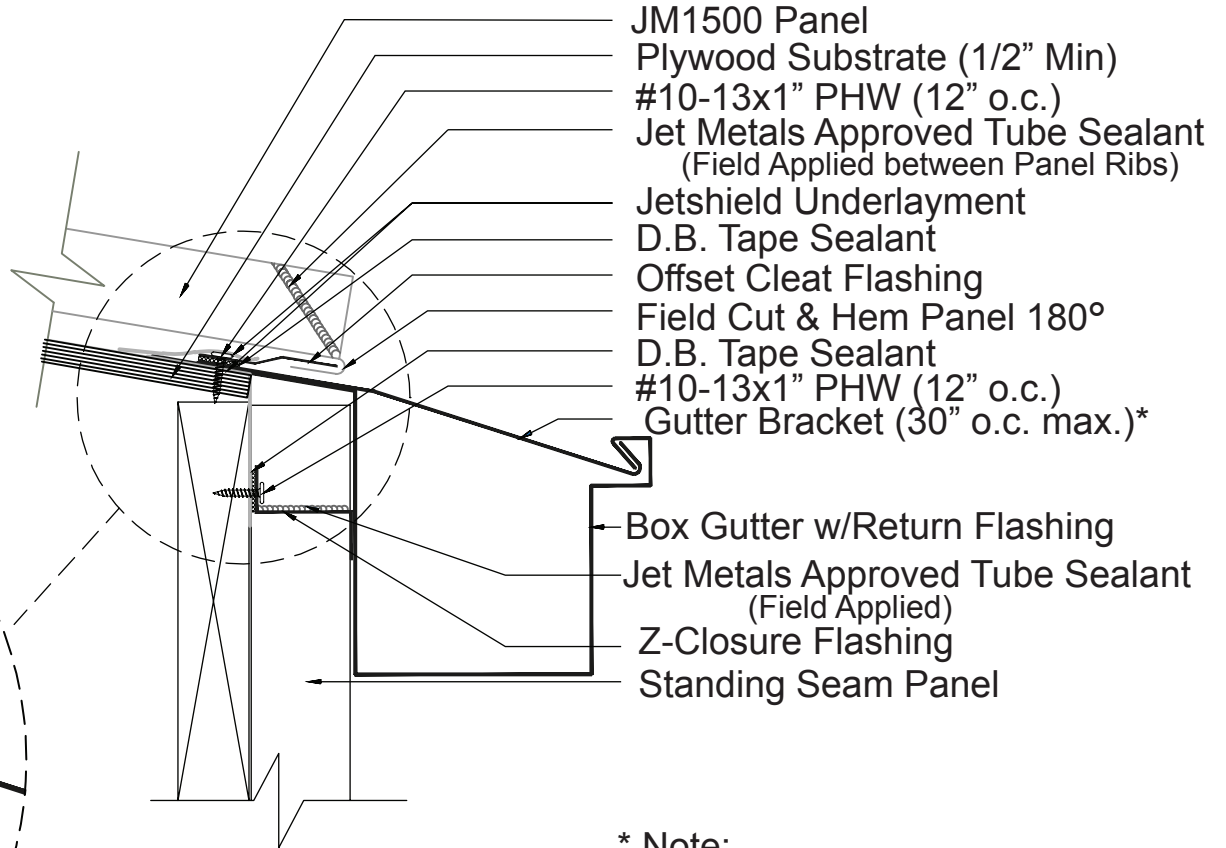

Plywood Substrate



- JM1500 Panel
- Plywood Substrate (1/2" Min)
- #10-13x1" PHW (12" o.c.)
- Jet Metals Approved Tube Sealant
(Field Applied between Panel Ribs)
- Jetshield Underlayment
- D.B. Tape Sealant
- Offset Cleat Flashing
- Field Cut & Hem Panel 180°
- D.B. Tape Sealant
- #10-13x1" PHW (12" o.c.)
- Gutter Bracket (30" o.c. max.)*
- Box Gutter w/Return Flashing
- Jet Metals Approved Tube Sealant
(Field Applied)
- Z-Closure Flashing
- Standing Seam Panel

* Note:
Design Loads May Require
Closer Spacing

JET METALS, LLC.

DRAWING NAME:
**JM1500 BOX GUTTER
w/Return - w/Standing Seam Panel**

REV: 0	DRAWING NUMBER:	A	SHEET: 1 of 1
DATE: 06/01/2015	DRAWN BY: Off Balance Digital Art	PAINT:	