

- Field Cut & Fold Over Rib
- Jet Metals Approved Tube Sealant  
(Field Applied between Panel Ribs)
- Field Cut & Hem Panel 180°
- Drip Edge Flashing
- JM1500 Panel
- #10-13x1" PHW (6" o.c.)
- Jetshield Underlayment
- Plywood Substrate (1/2" Min)
- UL Clip
- #10-13x1" PHW (6" o.c.)
- Cleat Flashing
- Fascia Flashing

Zoomed in View

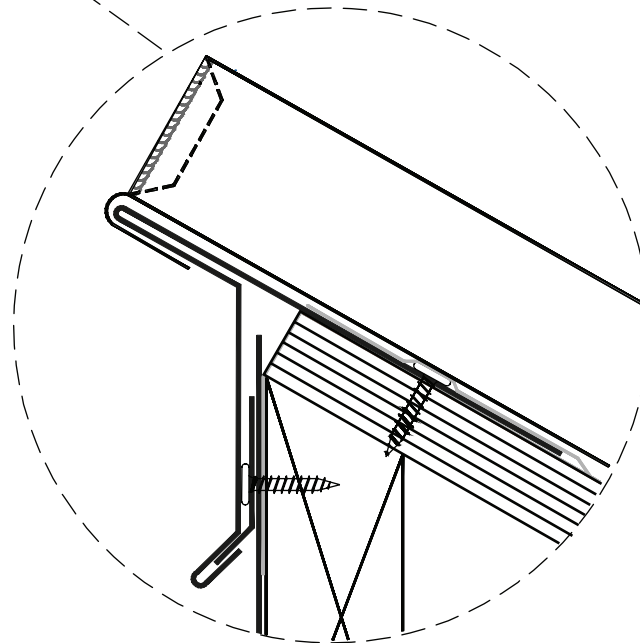

Plywood Substrate

**JET METALS, LLC.**

DRAWING NAME:

**JM1500 Drip Edge Peak**

REV: 0	DRAWING NUMBER:	<b>A</b>	SHEET: 1 of 1
DATE: 06/01/2015	DRAWN BY: Off Balance Digital Art	PAINT:	