

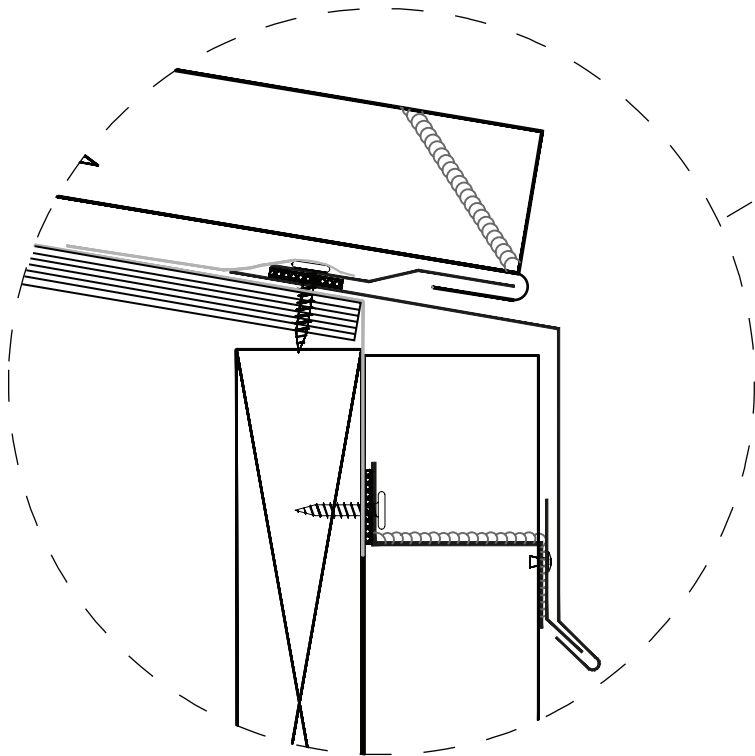

Zoomed in View

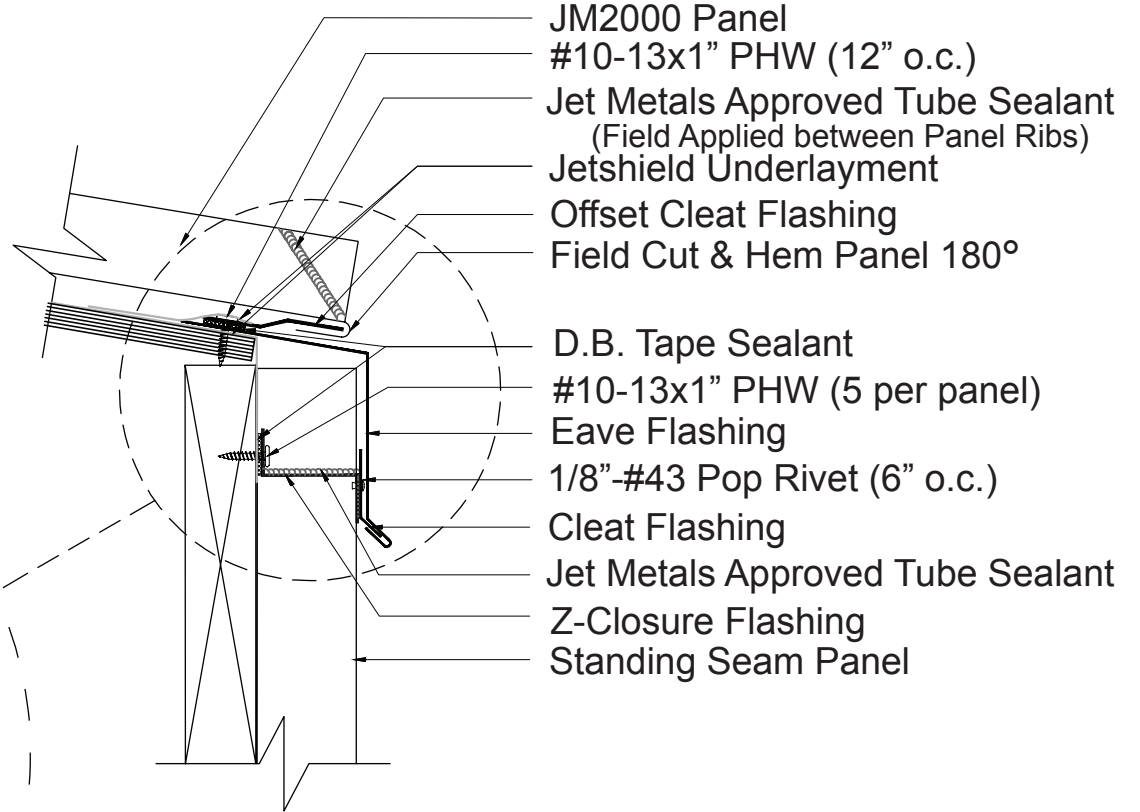

Plywood Substrate



- JM2000 Panel
- #10-13x1" PHW (12" o.c.)
- Jet Metals Approved Tube Sealant
(Field Applied between Panel Ribs)
- Jetshield Underlayment
- Offset Cleat Flashing
- Field Cut & Hem Panel 180°
- D.B. Tape Sealant
- #10-13x1" PHW (5 per panel)
- Eave Flashing
- 1/8"-#43 Pop Rivet (6" o.c.)
- Cleat Flashing
- Jet Metals Approved Tube Sealant
- Z-Closure Flashing
- Standing Seam Panel

JET METALS, LLC.

DRAWING NAME:

**JM2000 Eave
w/Standing Seam Panel**

REV: 0	DRAWING NUMBER:	A	SHEET: 1 of 1
DATE: 06/01/2015	DRAWN BY: Off Balance Digital Art	PAINT:	