

- Jet Metals Approved Tube Sealant
- Fasteners (by others)
- Jet Metals Approved Tube Sealant
- Reglet Flashing
- Box End of Panel
(see Zee Closure Options Detail)
- Headwall Flashing
- D.B. Tape Sealant
- #10-13x1" PHW (5 per panel)
- Jet Metals Approved Tube Sealant
- Z=Closure Flashing
- 1/8"-#43 Pop Rivet (18" o.c.)
- JM2000 Panel
- Plywood Substrate (1/2" min.)
- Jetshield Underlayment

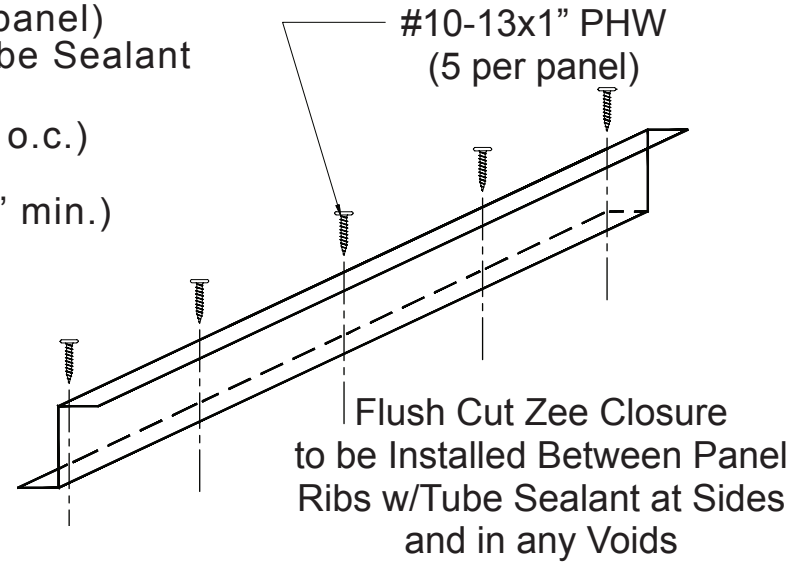

Zoomed in View

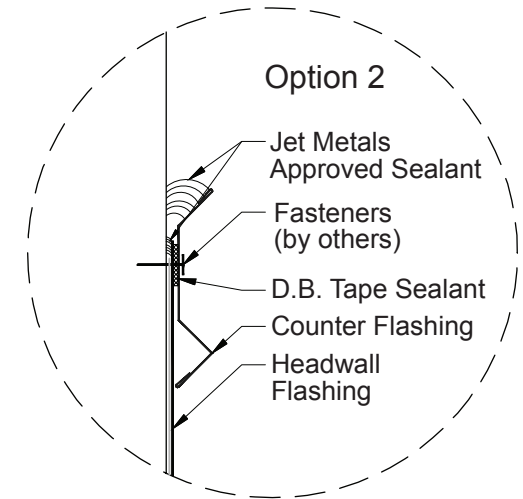
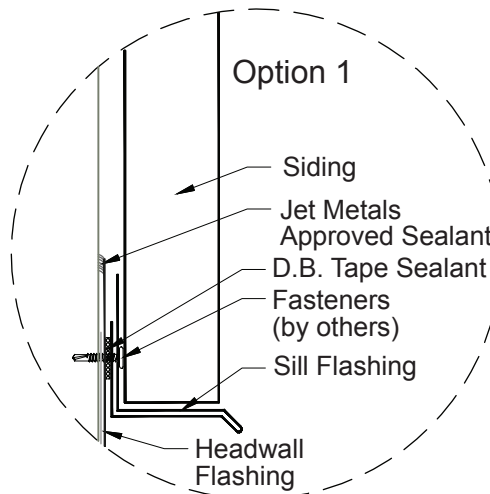

Plywood Substrate

JET METALS, LLC.

DRAWING NAME:

JM2000 HEADWALL

REV: 0	DRAWING NUMBER:	A	SHEET: 1 of 1
DATE: 06/01/2015	DRAWN BY: Off Balance Digital Art	PAINT:	