

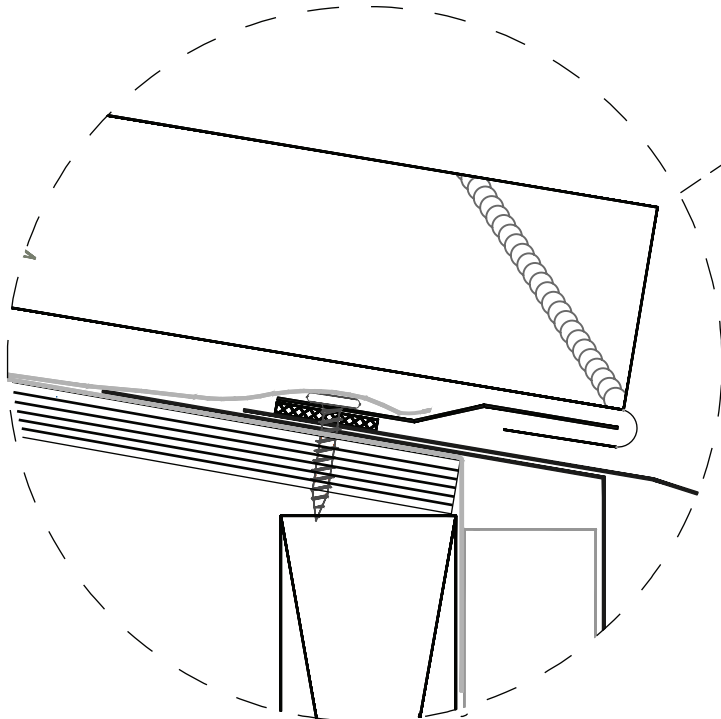

JET METALS
ROOF & WALL SYSTEMS

Zoomed in View



Plywood Substrate

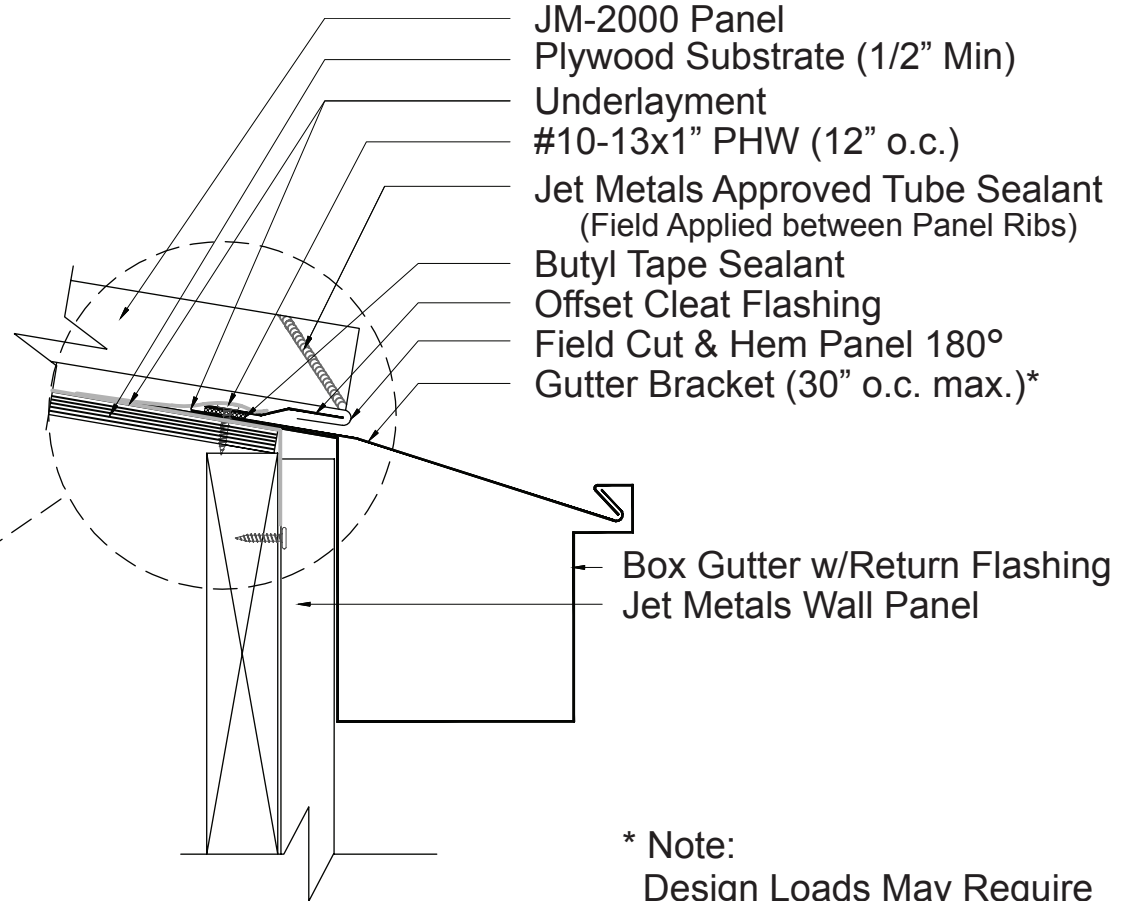

* Note:
Design Loads May Require
Closer Spacing

JET METALS, LLC

DRAWING NAME:

**JM-2000 BOX GUTTER
w/Return - w/Flush Panel**

REV: 0	DRAWING NUMBER:	A	SHEET: 1 of 1
DATE: 06/01/2015	DRAWN BY: Off Balance Digital Art	PAINT:	