

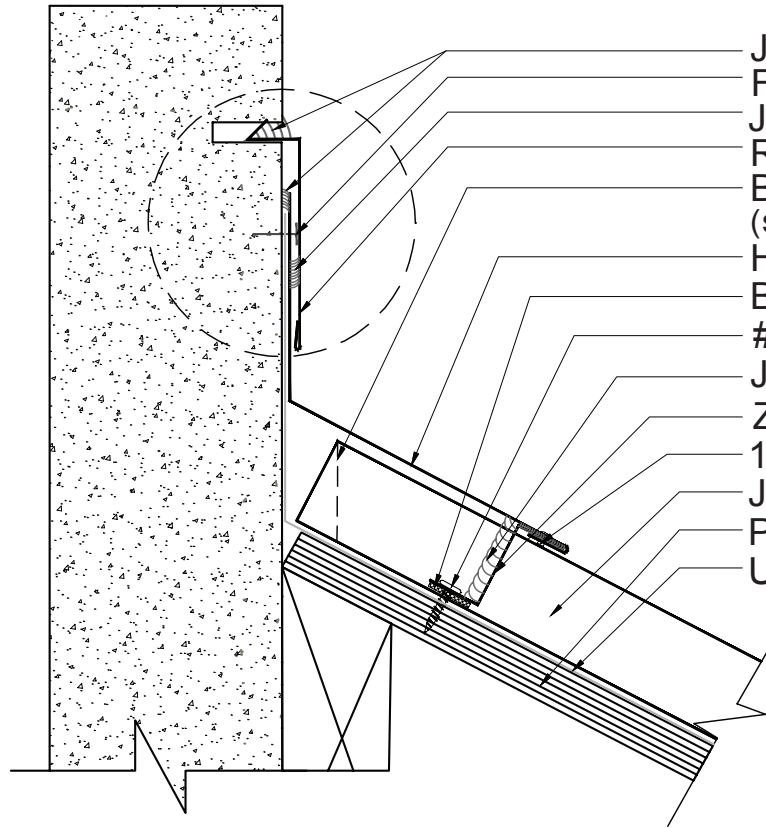

JET METALS
ROOF & WALL SYSTEMS

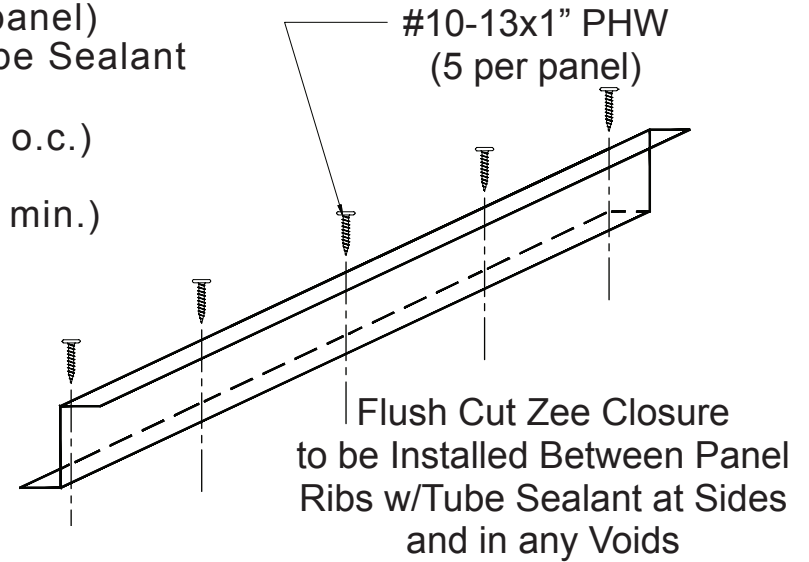

- Jet Metals Approved Tube Sealant
- Fasteners (by others)
- Jet Metals Approved Tube Sealant
- Reglet Flashing
- Box End of Panel
(see Zee Closure Options Detail)
- Headwall Flashing
- Butyl Tape Sealant
- #10-13x1" PHW (5 per panel)
- Jet Metals Approved Tube Sealant
- Z-Closure Flashing
- 1/8"- #43 Pop Rivet (18" o.c.)
- JM-1500 Panel
- Plywood Substrate (1/2" min.)
- Underlayment



Zoomed in View

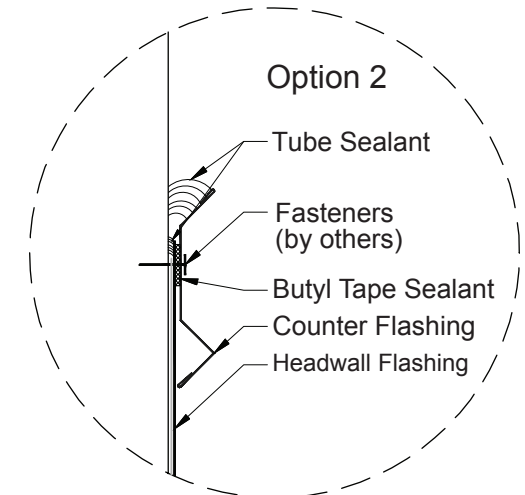
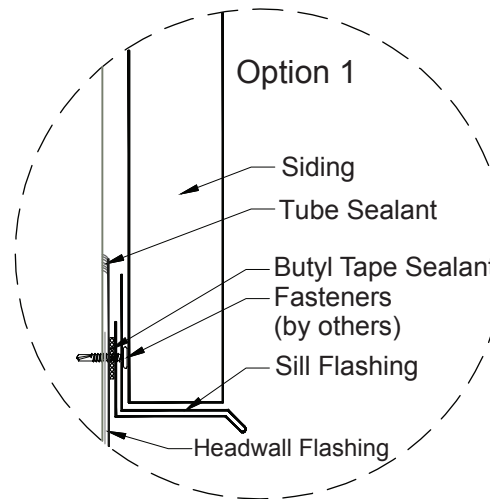

Plywood Substrate

JET METALS, LLC

DRAWING NAME:

JM-1500 HEADWALL

REV: 0	DRAWING NUMBER:	A	SHEET: 1 of 1
DATE: 06/01/2015	DRAWN BY: Off Balance Digital Art	PAINT:	