

Zoomed in View

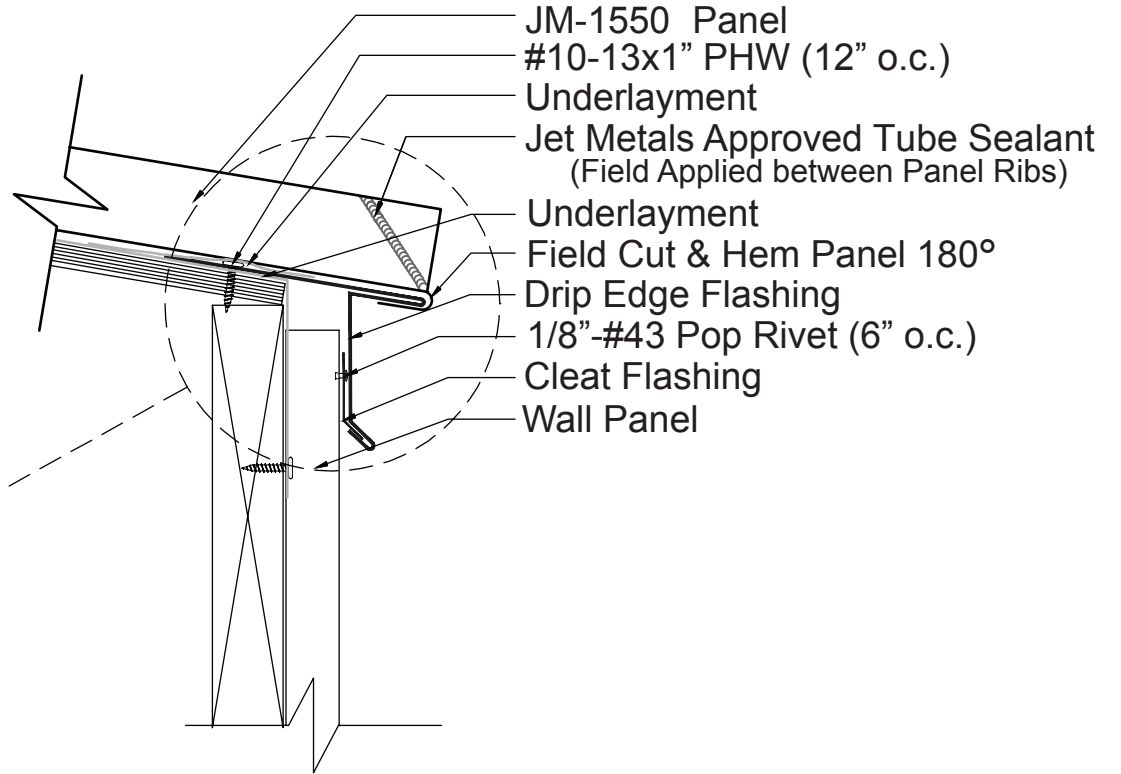
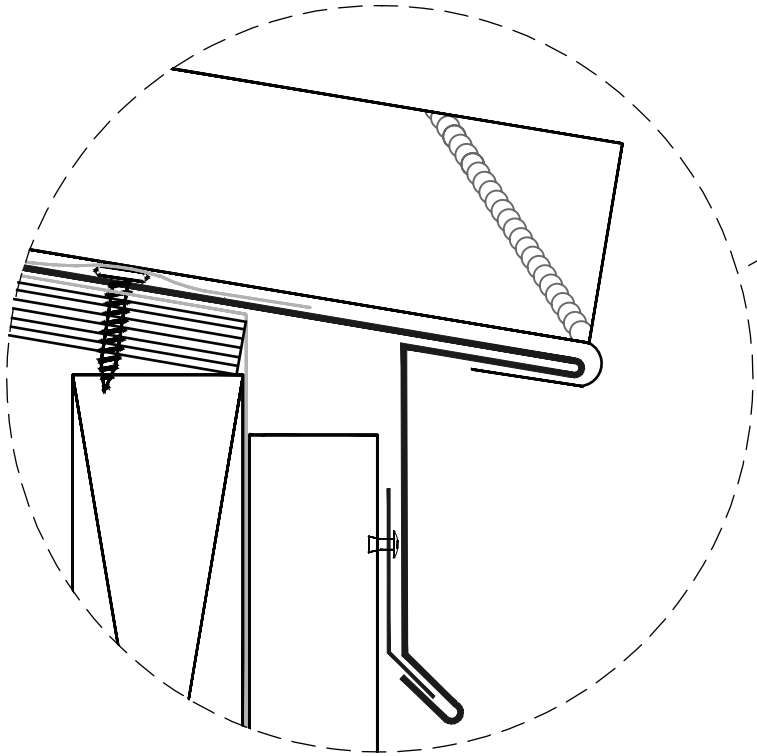

- JM-1550 Panel
- #10-13x1" PHW (12" o.c.)
- Underlayment
- Jet Metals Approved Tube Sealant  
(Field Applied between Panel Ribs)
- Underlayment
- Field Cut & Hem Panel 180°
- Drip Edge Flashing
- 1/8" -#43 Pop Rivet (6" o.c.)
- Cleat Flashing
- Wall Panel

Plywood Substrate

**JET METALS, LLC**

DRAWING NAME:  
**JM-1550 Drip Edge  
w/Flush Panel**

REV: 0	DRAWING NUMBER:	<b>A</b>	SHEET: 1 of 1
DATE: 06/01/2015	DRAWN BY: Off Balance Digital Art	PAINT:	



**JET METALS**  
ROOF & WALL SYSTEMS