

JET-74

Tuff-Rib Base Guard

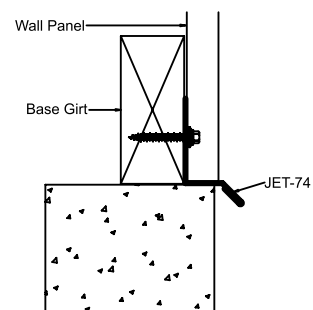
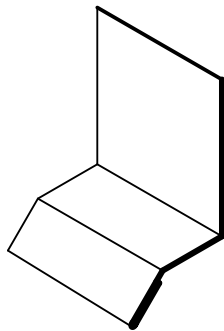
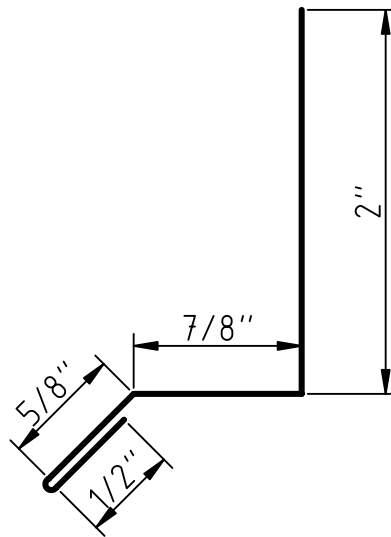

JET METALS
ROOF & WALL SYSTEMS

JET-74 Tuff-Rib Base Gaurd

09/09/2020 JDB

Tolerances:

Fractional: +/- 1/16"
Twist/Ski: 1/8" in 3'0"
Straightness/Camber: 1/4" in 10'0"